

Varenummer: 03491035
 Beskrivelse: Fluro Heavy Duty Ledhoved EA 35 EW-2RS
 M36x3 Udvendig gevind
 Note: 35

Mål

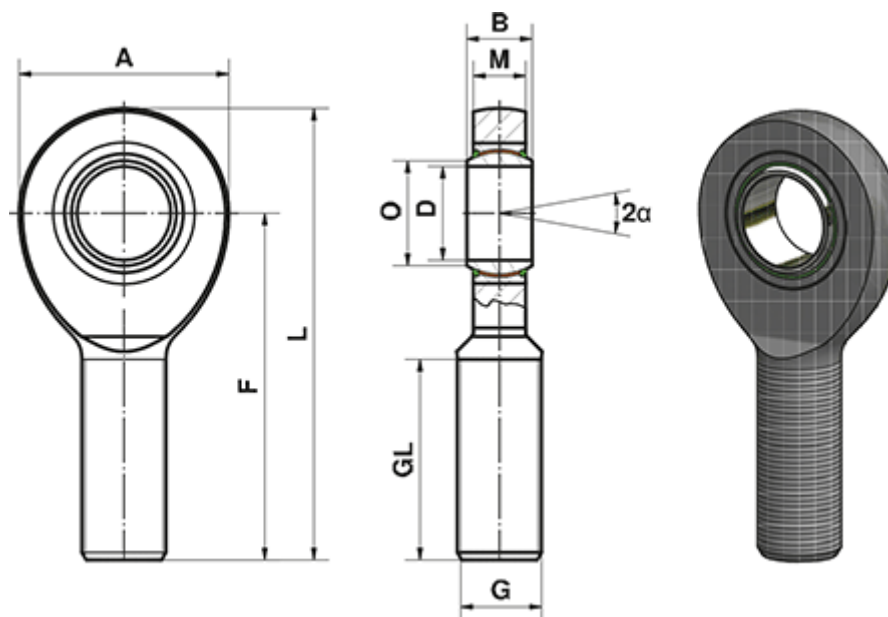

A	= 82	L	= 181
a (grader)	= 6	M	= 20
B	= 25	O	= 39.7
D	= 35	Statisk belastning C0 (kN)	= 144
Dynamisk belastning C (kN)	= 210	Vægt (g)	= 1400
F	= 140		
G	= M36x3		
GL	= 82		